

Network Management Card

User Manual

Contents

Contents	2
Chapter 1 Overview	3
1.1 NMC package contents	4
1.2 NMC CD Resources	4
1.3 Features	4
1.4 NMC Applications	5
Chapter 2 NMC parameters setting via serial COM port	6
2.1 Configure NMC via serial COM port	6
Chapter 3 NMC&UPS management via web browser	12
3.1 NMC Parameters setting via web browser	12
3.1.1 NMC System menu	12
3.1.2 Date and Time menu	13
3.1.3 Email Notification menu	13
3.1.4 SNMP TRAP Receivers menu	14
3.1.5 SNMPv1/2 Configuration	15
3.1.6 SNMPv3 User Management	16
3.1.7 Wake On LAN	17
3.1.8 Firmware Upload menu	18
3.1.9 File Management menu	18
3.1.10 System Log menu	19
3.1.11 Reboot system menu	19
3.1.12 Access Control	19
3.2 UPS monitoring via web browser	20
3.2.1 UPS Status menu	20
3.2.2 UPS Alarm menu	21
3.2.3 UPS Parameters menu	22
3.2.4 UPS Powered Devices Menu	22
3.2.5 UPS Identification menu	23
3.2.6 UPS Log menu	24
3.2.7 UPS Statistics Log menu	25
3.2.8 Event Log menu	26
3.3 UPS control via web browser	27
3.3.1 UPS Battery Test menu	27
3.3.2 UPS Battery Test Schedule menu	28
3.3.3 UPS Control menu	29
3.3.4 UPS Shutdown Schedule menu	30
3.3.5 UPS Shutdown menu	31
3.3.6 UPS Configuration menu	32
Chapter 4 NMC & UPS management via SNMP	34
Chapter 5 NMC Upgrade Tool - Find NMC in the LAN	35

Chapter 1 Overview

NMC (Network Management Card) can receive the status information of UPS, and also can send commands to control UPS. User can manage UPS with NMC via web browser or via network management software which supports SNMP protocol.

Once UPS output is abnormal or other events are touched off, NMC will protect server or client operating system being shut down safely by working with system protect software (SPS) that can be installed on various operating system. The conditions include: UPS output abnormal, UPS battery low, UPS overload, over temperature, schedule shutdown, etc. User can set the condition, once the event is touched off, NMC will inform SPS of the event and SPS will shut down operating system safely according to the setting of SPS.

Note: NMC is short for Network Management Card in the following description.

Network Management Card

1.1 NMC package contents

1. NMC with mounting bracket, packaged with ESD bag.
2. RJ45 to DB9 converter cable.
3. Quick Installation Guide.
4. NMC CD-ROM.

1.2 NMC CD Resources

NMC CD-ROM contains NMC Upgrade Tool, Quick Installation Guide, User Manual, MIB files, System Protect Software for various OS, and NMC firmware upgrade SOP.

1. NMC Upgrade Tool--- for searching NMC in LAN and linking to web of the card
2. Quick Installation Guide --- for describing how to configure NMC
3. User Manual --- for NMC function introduction and settings
4. MIB files --- for SNMP monitoring use
5. System Protect Software --- for protecting server or client operating system shutdown safely
6. NMC firmware upgrade SOP --- for describing how to upgrade NMC firmware

1.3 Features

- **UPS management by network connection through RJ45 connector**

User can monitor UPS status and control UPS via web browser on the internet.

- **UPS and NMC configuring via SNMP protocol**

User can configure parameters of NMC and control UPS via SNMP protocol on a network management station.

- **RTC function supporting**
- **Standard MIB (RFC1628.mib) and user-defined MIB (EPPC.mib)**
- **EMP (Environment Monitoring Probe) supporting**
- **SSL supporting**
- **Operating system shutdown safely**

System Protect Software can protect server or client operating system shutdown safely.

- **Redundant UPS input shutdown**

If there is more than one UPS supply power to server, user can configure the redundant UPS input shutdown function of SPS (System Protect System), SPS will shut down server safely when the last one UPS can't supply power.

Network Management Card

1.4 NMC Applications

NMC is kind of SNMP (Simple Network Management Protocol) manager to communicate UPS via Ethernet, it provides access information and send commands for the UPS. NMC supports two communicating protocols which are SNMP and HTTP for application. Through NMS (Network Management Station) or web browser user can access UPS information via Ethernet directly, meanwhile user can manage both UPS and NMC parameters as well.

NMC provides an application program which named SPS (System Protect Software) for multi-servers shutdown purpose. The program provides shutdown function for different operating systems when shutdown events are appearing on UPS. Shutdown events are configurable by user. The shutdown software will proceed the automatic shutdown orderly to prevent the abnormal shut-off of the clients or servers.

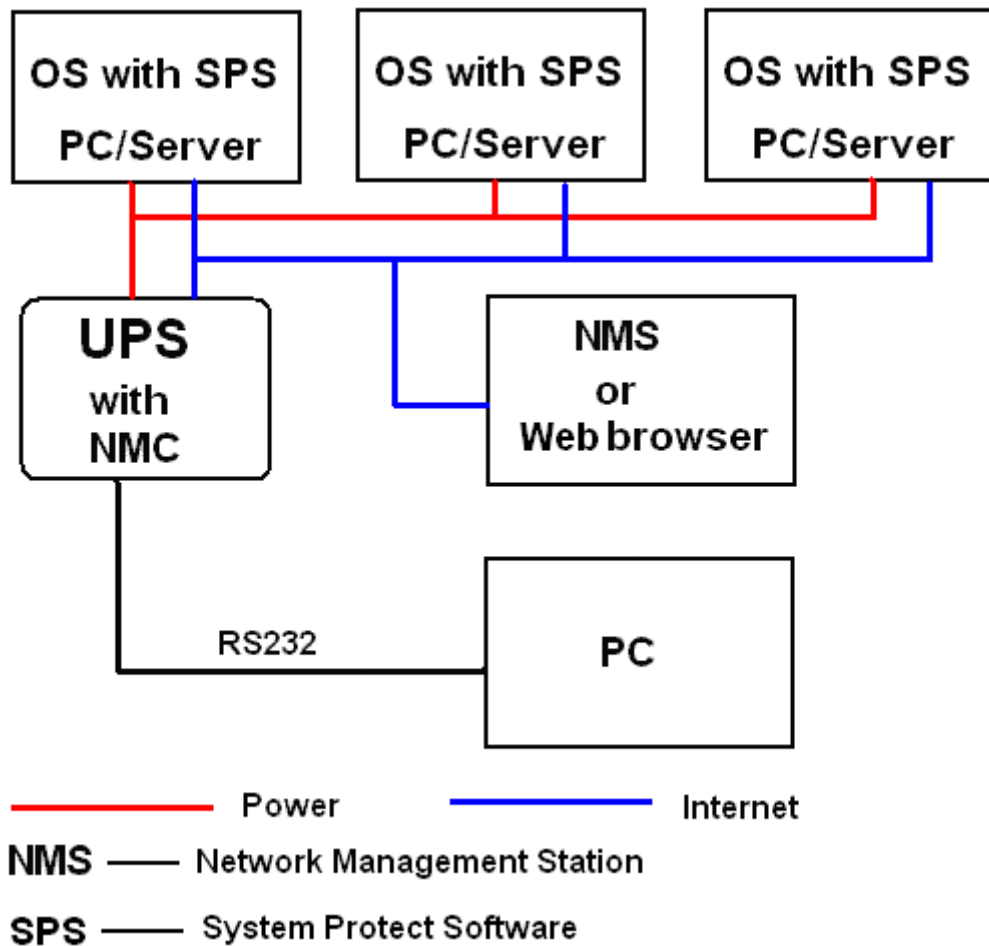

Chapter 2 NMC parameters setting via serial COM port

There are more methods for NMC parameters setting: setting via serial COM port, setting via telnet program, setting via SSH, and setting via web browser. It offers basic parameters setting through a serial COM port for NMC configuration such as IP Configuration, Pass Through, and Reset Configuration to default, Restart and Password. In this section, it particularly introduces the parameters setting via serial COM port. It is worth mentioning that the telnet/SSH program settings menu is same with the serial port settings.

2.1 Configure NMC via serial COM port

1. Prepare a computer (with Microsoft Windows XP or later version)
 2. Insert NMC into UPS's intelligent slot exactly.
 3. Tighten NMC with screw.
 4. Connect the serial port of computer with NMC via RJ45 to DB9 converter cable, the cable is supplied in NMC package.
 5. On the computer with Microsoft Windows, for XP operation system, select **Hyper Terminal** from **start→all programs** to communicate with serial port; For XP above version, communicate with serial port via serial port debug tool (Putty is used as example in this manual).
- For Windows XP or other Windows operation system that support Hyper Terminal, select **Accessories→Communication→Hyper Terminal** to create serial communication.

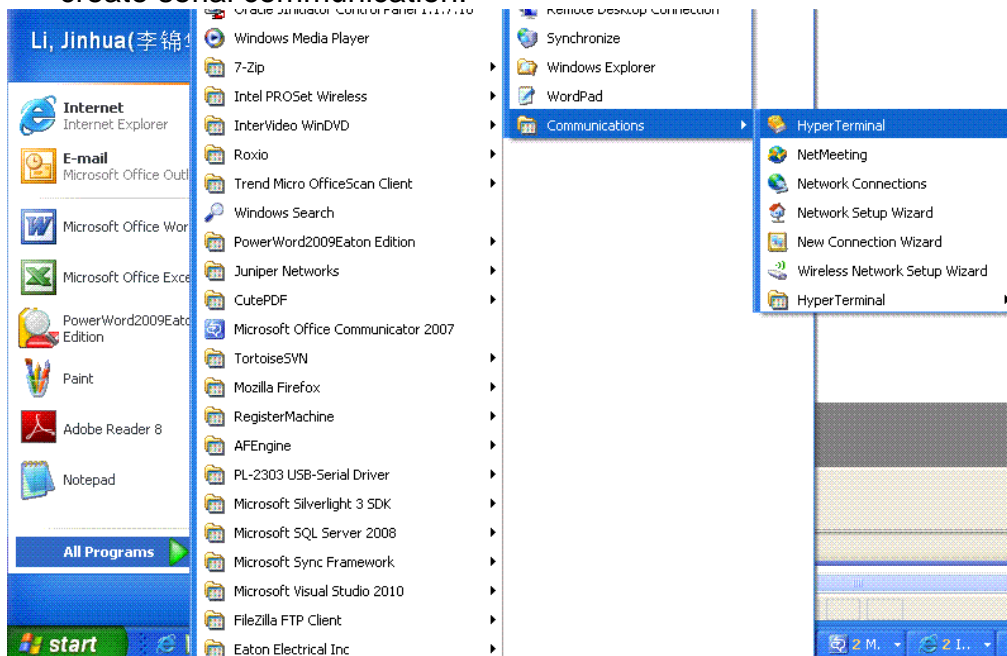

Input a name and select the connection icon.

Network Management Card



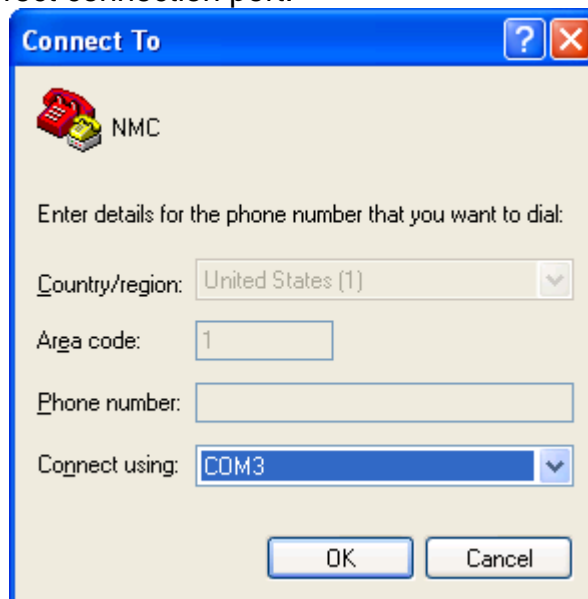

Select the correct connection port.

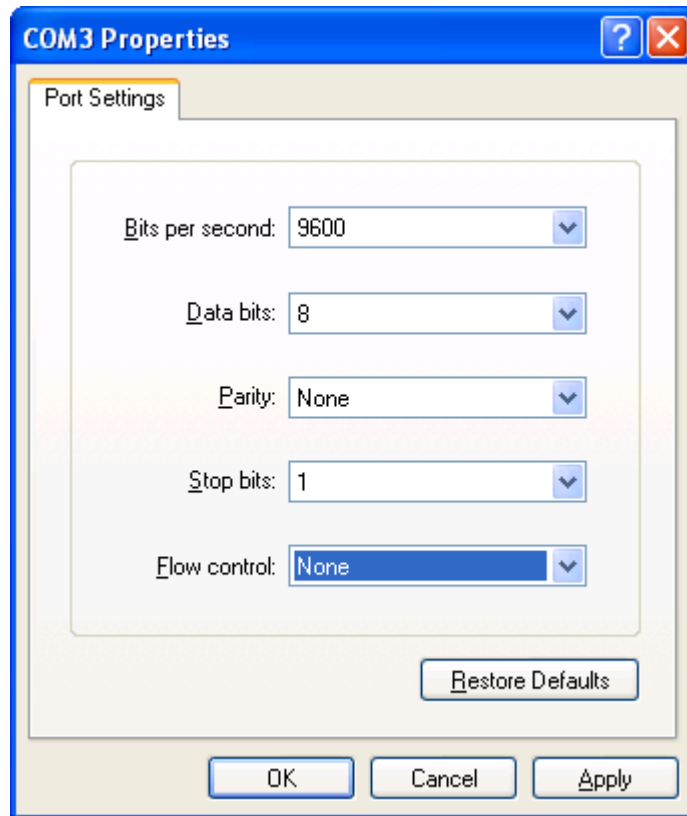

Configure the parameters of the serial port: **9600** bps, **8** bits, **None** parity, **1** stop bit and **None** flow control.

Network Management Card



- For XP above Windows version, communicate with serial port via serial port debug tool. Double click Putty icon  putty.exe, open Putty and select serial session, configure the correct serial port and baud rate 9600 bps.

Network Management Card

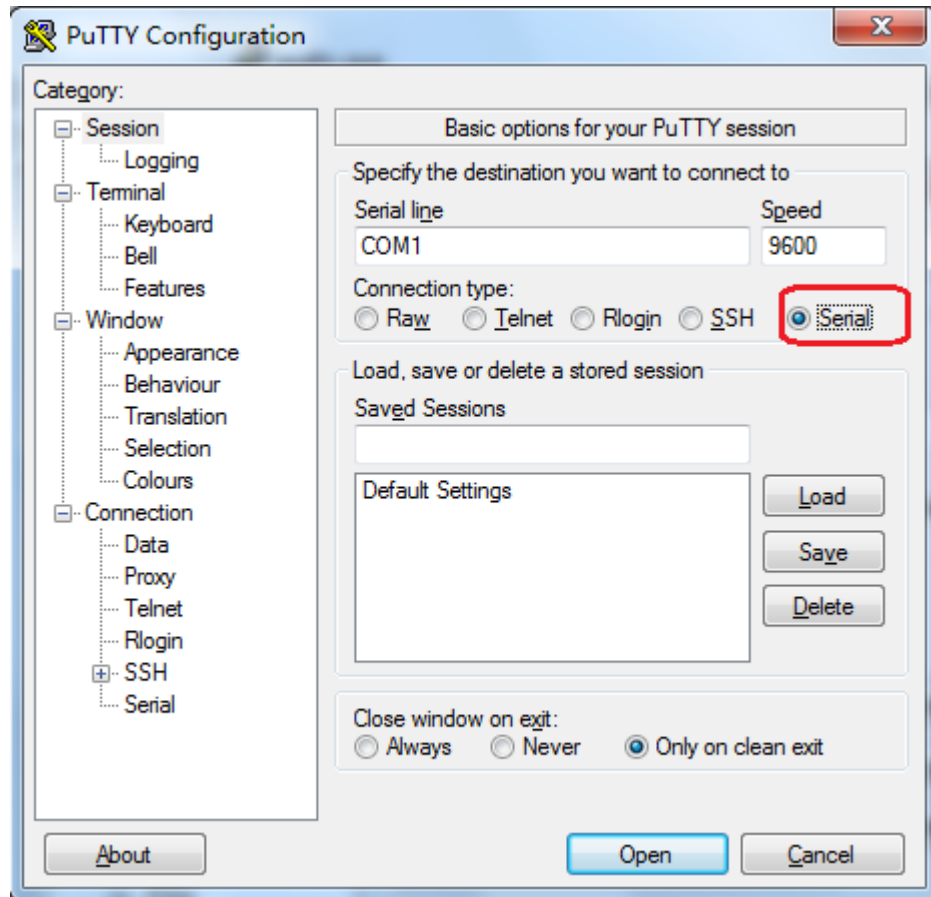

Select “Serial” node on the left tree, and configure the parameters of the serial port on the right window: **9600** bps, **8** bits, **None** parity, **1** stop bit and **None** flow control. And then open the putty serial communication window by click “open” button.

Network Management Card

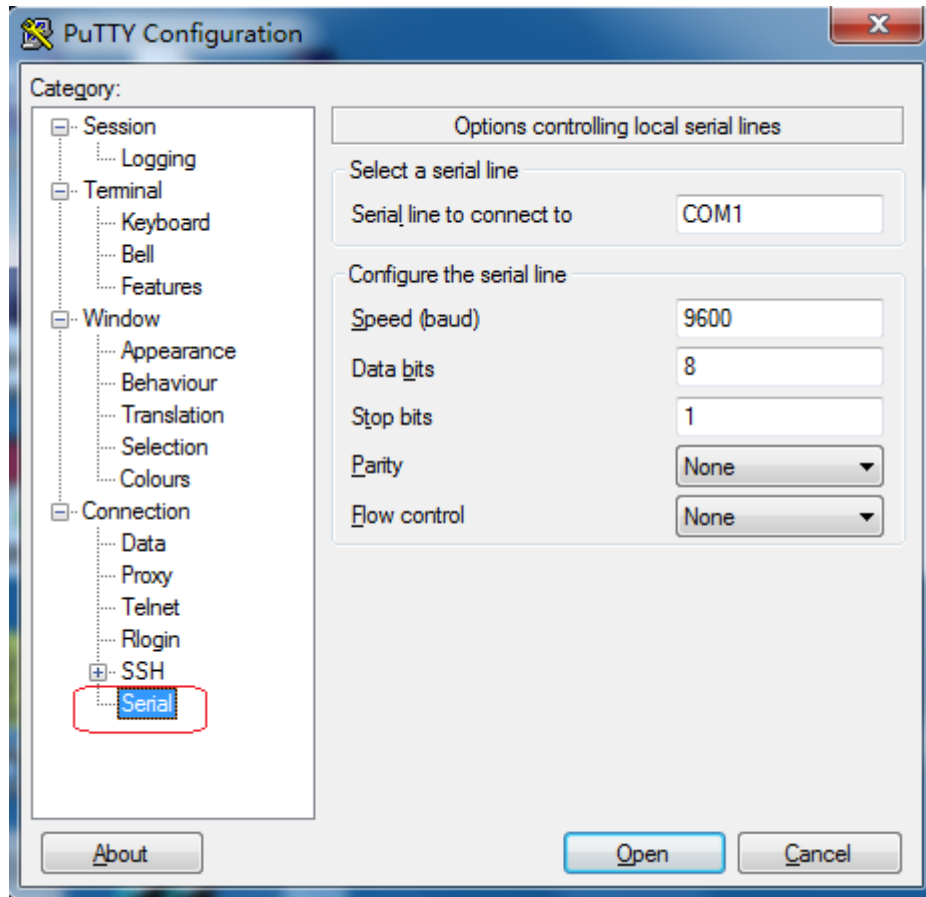

6. Please turn on UPS and waiting NMC start successfully, there will be some information shown on the hyper terminal interface. Refer to the following diagram, input NMC password, the default password of NMC is **password**

```
NMC Version X.X.X.X
+-----+
|           Network Management Card Configure Menu           |
+-----+
Password: _
```

7. After inputting the NMC password, all main menus will be shown on the hyper terminal interface, refer to the following diagram.

```
+-----+
|           Network Management Card Configure Menu           |
+-----+
1. IP Configurations
2. Pass Through
3. Reset Configuration to default
4. Restart
5. Change Password
0. Exit
```

Please Enter Your Choice :

8. Basing on the main menus, please select “1” to configure IP address, gateway, subnet mask and DHCP, refer to the following diagram.

Network Management Card

```
+-----+
|                                     IP Configure Menu                                     |
+-----+
  MAC Address : 00:20:85:F7:10:1F
1. DHCP      : Enable
  IP address  : 172.18.127.42
  Subnet mask : 255.255.255.0
  Gateway     : 172.18.127.1
  Primary DNS address : 172.18.121.17
  Secondary DNS address : 151.110.232.21
7. IPv6 Configure
0. Return to previous menu
```

Please Enter Your Choice :

9. Basing on the main menus, please select "2" to send command to UPS, the function is just for double checking UPS reply data correctly or not.
10. Basing on the main menu, please select "3" to configure NMC parameters to default value.
11. Basing on the main menus, please select "4" to restart NMC.
12. Basing on the main menus, please select "5" to modify NMC password.
13. Basing on the main menus, please select "0" to exit main menus. It is suggested exit the main menu page when the configurations is completed, and then close the serial debugging tool.

Note: User can configure NMC through Telnet program; the menu options of Telnet program are as same as the serial port setting menu.

Chapter 3 NMC&UPS management via web browser

In this section, it particularly introduces how to configure NMC, manage UPS and monitor UPS parameters via web browser.

3.1 NMC Parameters setting via web browser

Please Note: Before implementing the NMC setting for all configuring parameters, user has to become NMC administrator first. While configure parameters for NMC via web browser, there will be a pop-up dialog to ask the name and password of NMC administrator. Only NMC password can be changed, regarding to change password by serial COM port, please refer to the item 15 of the section 2.1.

3.1.1 NMC System menu

NMC system menu can be accessed by **Settings**→**NMC System**. In this menu it offers configuring for DHCP function, default is enabled; NMC IP address; SNMP version; Modbus TCP Connection; SMTP function; UPS description; UPS location; NMC web language change function and data log interval. Please refer to the following diagram 3.1.1.

Please Note: NMC must restart via Reboot System menu after changed IP address via web browser to make IP setting active immediately.

The screenshot shows a web browser window with the URL <http://172.18.140.201/>. The page title is "NETWORK MANAGEMENT CARD FOR UPS" and it shows the user is "ON-LINE" at "Location: Office" on "2018/04/11 15:49:52".

The left sidebar contains a navigation menu with categories: UPS Monitoring, UPS Management, Settings, and Logs. The "Settings" category is expanded, and "NMC System" is selected.

The main content area is titled "Settings » NMC System" and contains two sections of configuration options:

System Configuration	
BootP/DHCP	Enable
IP Address	172.18.140.201
Subnet Mask	255.255.255.0
Gateway Address	172.18.140.1
Primary DNS	151.110.232.100
Secondary DNS	151.110.232.49
IPv6	Enable
IPv6 Auto Configuration	Enable
IPv6 Address 1	:
Prefix length	0
IPv6 Gateway Tunnel	0.0.0.0
IPv6 Local Address	FE80::220:85FF:FEF7:1016
IPv6 Address 2	:
Save	

SNMP Support	SNMP v1
Telnet Connection	Enable
SSH Connection	Disable
ModbusTCP Connection	Disable
SMTP	Enable
Login required for web access	Disable
UPS Description	
UPS Location	Office
Default Language	Auto
History Log Interval(Sec)	20
Statistics Log Interval(Min)	2
Save	

Diagram 3.1.1

3.1.2 Date and Time menu

Date and Time menu can be accessed by **Settings→Date and Time**. There are three methods for configuring NMC date and time: configure the date and time of NMC same as user's computer; manually setting the date and time through input the date and time by user self; enter the NTP server address and select a time zone, make the NMC clock synchronized with the NTP server time. Please refer to the following diagram 3.1.2.

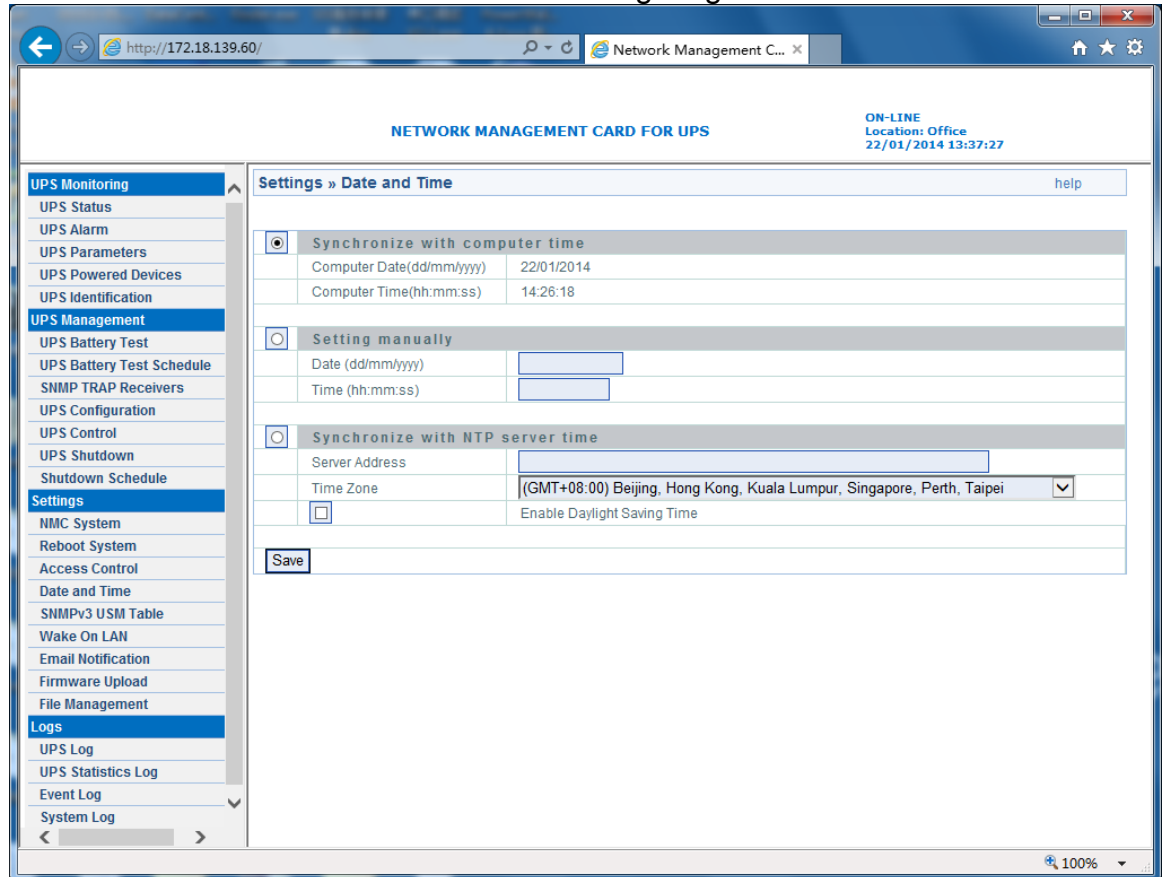

Diagram 3.1.2

3.1.3 Email Notification menu

Email Notification menu can be accessed by **Settings→Email Notification**. NMC will send an Email to user when UPS event happens. Email Message Setting, there are columns which Mail Server, User Account, User Password, Sender's Email address, Mail Subject Prefix, Mail Server Port, Mail Daily Report At and Attached File must be input according to what user wants to define.

there are three encryption methods : NONE, SSL and TLS

Recipient List Settings, four Email receiver address can be configured at most; user can input description for each Email address. The functions of Mail Type and Event Level are as following.

Email Type:

- None: It means that NMC won't send any Email to the mail account when event happens on UPS.
- Events: It means that NMC will send an Email when to the mail account when event happens on UPS.
- Daily status: It means that NMC will send UPS daily logs reports to the mail account and the delivery time is configured by "Mail Daily Report

Network Management Card

At” column. Note: user is able to select History Log, Event Log and System Log report by tick Attached File column.

- Events/Status: It means that NMC will send an event report to the mail account when event happens on UPS and meanwhile NMC will send the daily logs reports as well.

Event Level:

- Information: It means that NMC will send an Email to the mail account once event happens on UPS.
- Warning: It means that NMC will send an Email to the mail account once warning event happens on UPS.
- Severe: It means that NMC will send an Email to the mail account once severe event happens on UPS.

Refer to the following diagram 3.1.3.

The screenshot shows the 'Settings > Email Notification' page in the Network Management Card for UPS. The page title is 'NETWORK MANAGEMENT CARD FOR UPS' and it shows 'ON-LINE Location: Office 27/06/2017 09:33:40'. The left sidebar contains various menu items like 'UPS Monitoring', 'UPS Management', 'Settings', and 'Logs'. The main content area is divided into 'Email Message Settings' and 'Recipient List Settings'.

Email Message Settings:

- Mail Server: smtp-mail.outlook.com
- User Account: lingawu@outlook.com
- User Password: [Redacted]
- Sender's Email Address: lingawu@outlook.com
- Mail Subject Prefix: NMC-587-TLS
- Mail Server Port: 587
- Mail Daily Status Report At: 10:40
- Encryption: TLS
- Attached Files: History Log Event Log System Log

Recipient List Settings:

Index	Mail Account	Description	Mail Type	Event Level
1	lisawu@eaton.com		Events	Information
2	linhuaLi@eaton.com		Daily Status	Information
3	lingawu@outlook.com		Events/Status	Information
4	lingawu@163.com		Events/Status	Information

Buttons: 'Send Test' and 'Set Value'.

Diagram 3.1.3

3.1.4 SNMP TRAP Receivers menu

SNMP trap receivers menu can be assessed by **UPS Management** → **SNMP TRAP Receivers**. In this menu, the columns NMS IP address, Trap Type, Severity and Description are configured by user's demand. The default of Community Strings column is "public", and it can't change by anyone. Trap type support two trap types which are RFC1628 Trap and EPPC Trap.

Severity:

- Information: It means that NMC will send a trap message to the NMS IP address once event happens on UPS.
- Warning: It means that NMC will send a trap message to the NMS IP address once warning event happens on UPS.

Network Management Card

- Severe: It means that NMC will send a trap message to the NMS IP address once severe event happens on UPS.

User can input description for each NMS IP address in description column. Refer to the following diagram 3.1.4.

The screenshot shows a web browser window displaying the 'NETWORK MANAGEMENT CARD FOR UPS' interface. The browser address bar shows 'http://172.18.139.60/authority_ok.html'. The page title is 'NETWORK MANAGEMENT CARD FOR UPS' and it indicates 'ON-LINE Location: Office 22/01/2014 13:40:52'. The main content area is titled 'UPS Management » SNMP TRAP Receivers' and contains a table with the following data:

Index	NMS IP Address	Community String	Trap Type	Severity
1	172.18.139.127	*****	RFC1628 Trap	Warning
2	172.18.139.27	*****	EPPC Trap	Information
3		*****	None	Information
4		*****	None	Information
5		*****	None	Information
6		*****	None	Information
7		*****	None	Information
8		*****	None	Information

A 'Save' button is located at the bottom right of the table. The left sidebar contains a navigation menu with categories: UPS Monitoring, UPS Management, Settings, and Logs.

Diagram 3.1.4

3.1.5 SNMPv1/2 Configuration

NMC Support SNMPv1 and SNMPv2 monitor, refer to Diagram 3.1.5.

User can set SNMPv1 and SNMPv2 community strings.

The default public community string is public. And the private community string is private.

Network Management Card

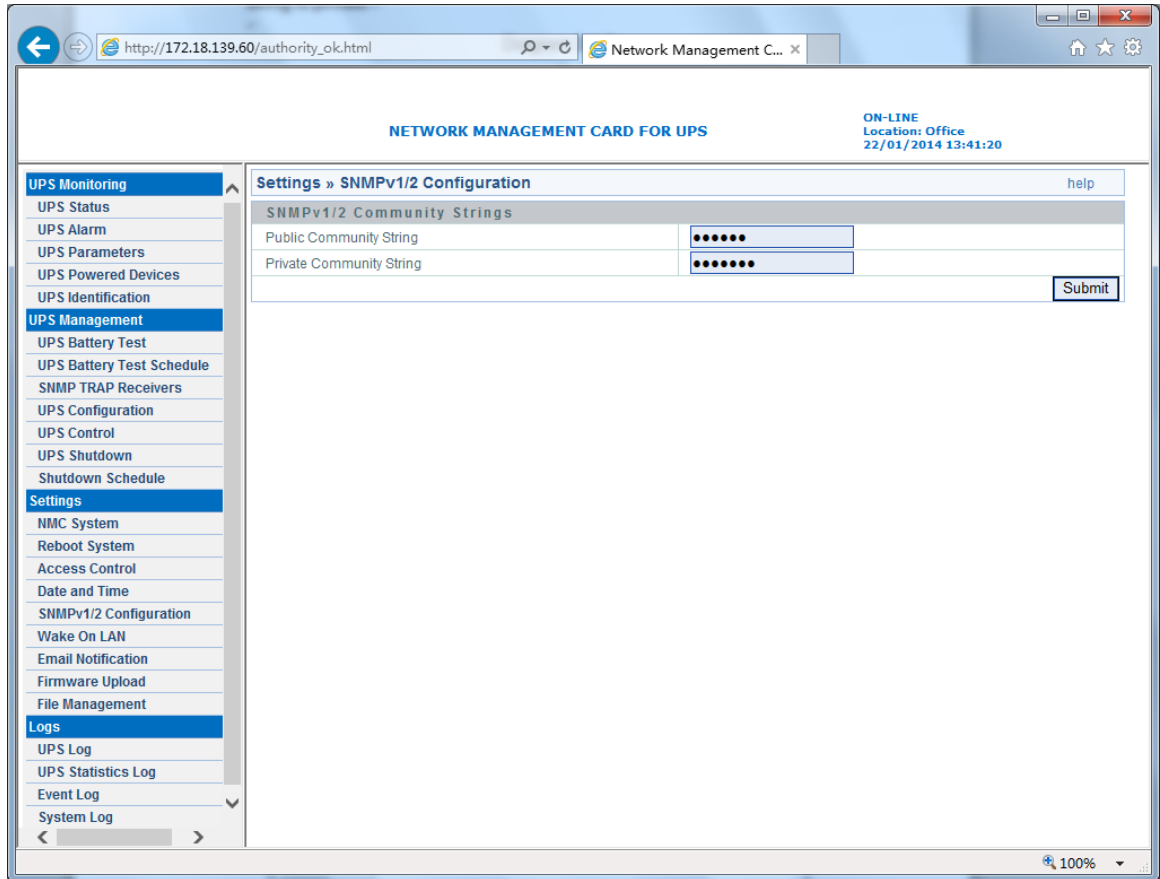

Diagram 3.1.5

3.1.6 SNMPv3 User Management

To enhance security users can enable SNMPv3 management mechanism, NMC can add SNMPv3 user through setting user name and validate password.

Enter **Settings** → **NMC System**, select SNMP Support to SNMPv3, the SNMPv3 menu option will appear to the left window, and then select **settings** → **SNMPv3 USM Table** to add SNMPv3 user, refer to Diagram 3.1.6.

User need set SNMPv3 user name, Authentication password, Private password, Security level, Authentication, User status.

Security level can choose no Authentication no Private password, Authentication but no Private, or both Authentication and Private password;

Authentication is MD5 encryption mode;

User status can choose enable or disable.

Network Management Card

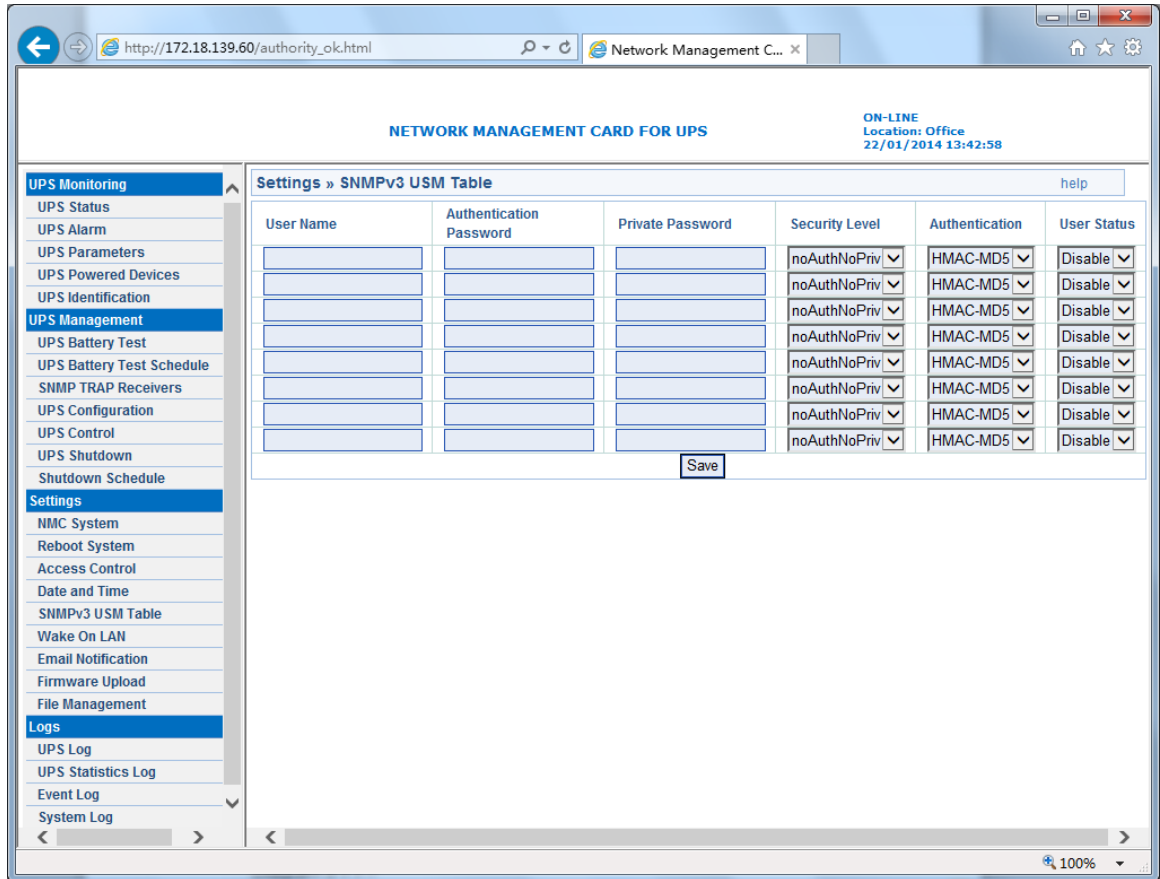

Diagram 3.1.6

3.1.7 Wake On LAN

Wake On LAN menu can be accessed by **Settings→Wake On LAN**. This menu is used to start up client computer from network by MAC address. When the client PC shutdown cause of UPS shutdown events, "Wake On LAN" packet will send to client to start up PC after shutdown events returned the normal. User can set almost 16 MAC address of client from this page. Refer to Diagram 3.1.7.

Network Management Card

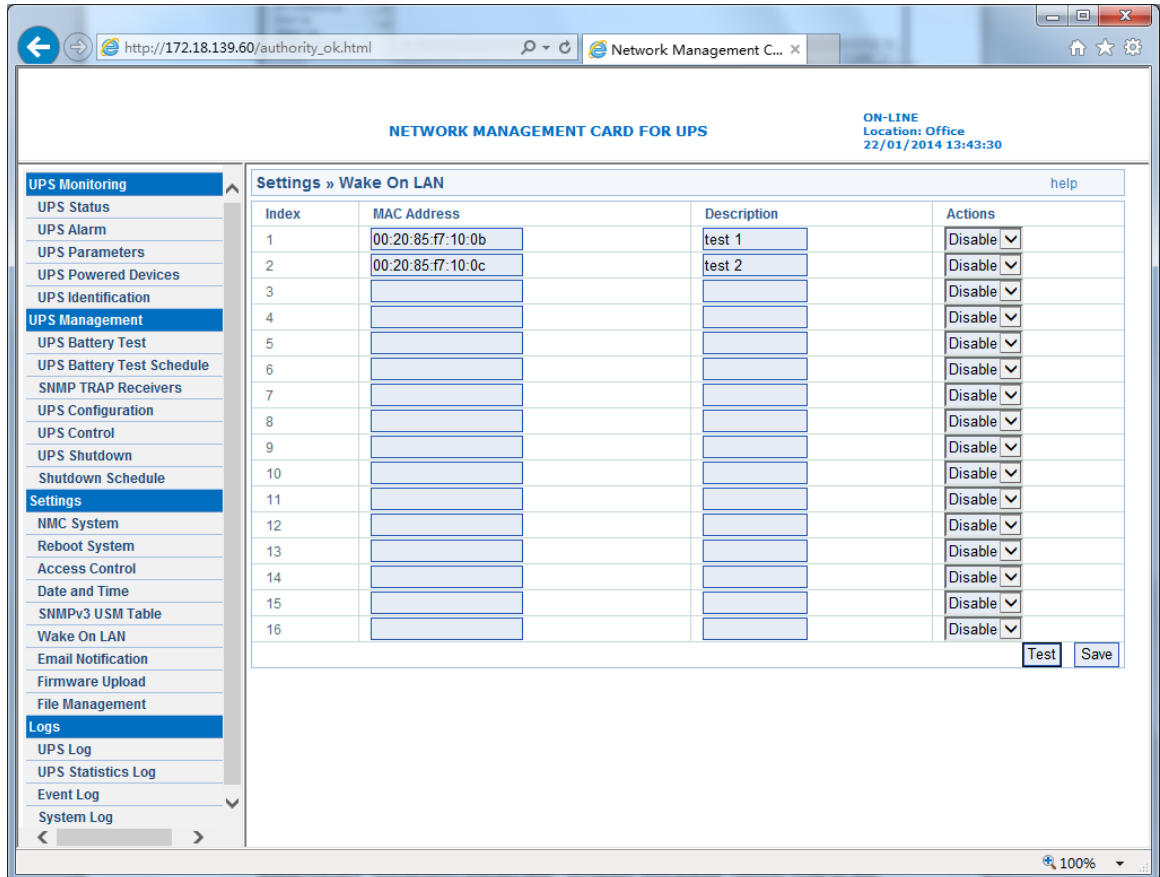

Diagram 3.1.7

3.1.8 Firmware Upload menu

Firmware upload menu can be accessed by **Settings→Firmware Upload**. This menu offers upload NMC firmware via web browser. When user is going to upload NMC firmware, user has to become administrator of NMC first. The default name is “**root**”, and the default password is “**password**” for login as administrator. Regarding upload NMC firmware procedure, please refer to the file [NMC Firmware Upgrade SOP.pdf](#) for detail information.

3.1.9 File Management menu

NMC file management menu can be accessed by **Settings→File Management**. The function of this menu is uploading files for the same configuration for different NMC. Only **confsnmp.cfg** (about NMC parameters) and **confups.cfg** (about UPS parameters set by NMC) these two files are available for application. After uploaded files NMC has to reboot immediately to make new configuration active. Regarding to reboot NMC system via web browser, please refer to section 3.1.9 and for reboot NMC system via serial COM port, please refer to item 14 in section 2.1. Furthermore it also can reboot NMC system manually by pull-out and push-in NMC from the intelligent slot of UPS.

Note: Once .cfg file is deleted, and then reboots NMC system. The configuration of NMC system and UPS will be back to the default setting.

If user would like to save .cfg and .csv file on local computer, it can be achieved by click the file name directly.

Network Management Card

3.1.10 System Log menu

NMC system log menu can be accessed by **Logs→System Log**. The menu allows user to view NMC system logs. Please refer to diagram 3.1.10.

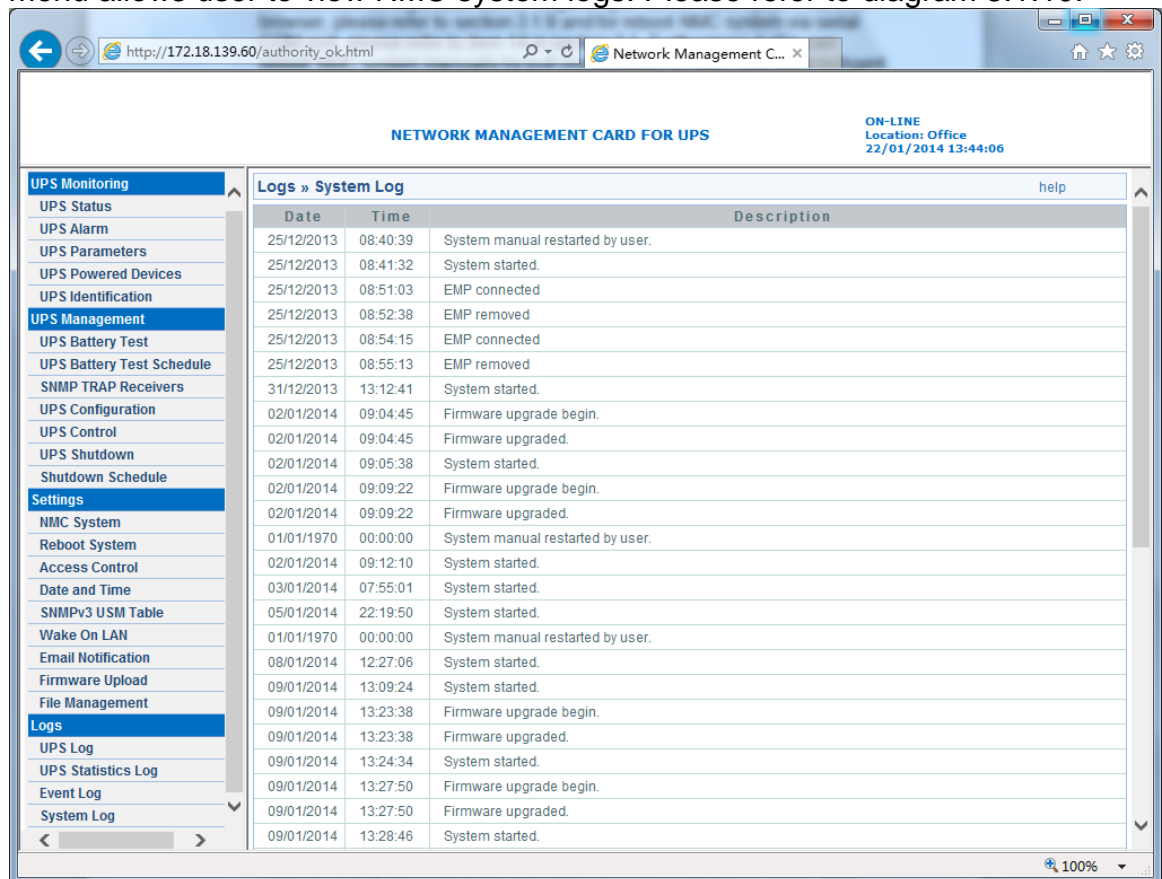

Diagram 3.1.10

3.1.11 Reboot system menu

NMC reboot system menu can be accessed by **Setting→Reboot System**. The menu offers a function for user to reboot NMC system if it is necessary. When user is going to reboot NMC system, user has to become administrator of NMC first. The default name is "**root**" and the default password is "**password**" for login as administrator.

3.1.12 Access Control

SNMP/HTTP Access Table menu can be accessed by **Setting→Access Control**. This menu displays a list of the workstations enabled access to NMC. User can enter workstation's IP address in IP Address column. 0.0.0.0 means entry not configured. User can choose access type in Access Type column, the available options are: Enable/Disable. "Enable" means the entry IPs have access to visit NMC via web or SNMP, "Disable" means the entry IPs have no access to visit NMC. For example, an entry 192.168.1.255 means the client with the IP address within the range from 192.168.1.0 to 192.168.1.255 become the management station with the access type set by Administrator. Please note 255.255.255.255 grant the access right to all IP. Please refer to diagram 3.1.12.

Change Password menu can be accessed by **Setting→Access Control**. User can change password in this menu. Default password is "password". If user forget password, can enter "B56hefT23st0" in console as password. Please refer to diagram 3.1.12, 3.1.13

Network Management Card

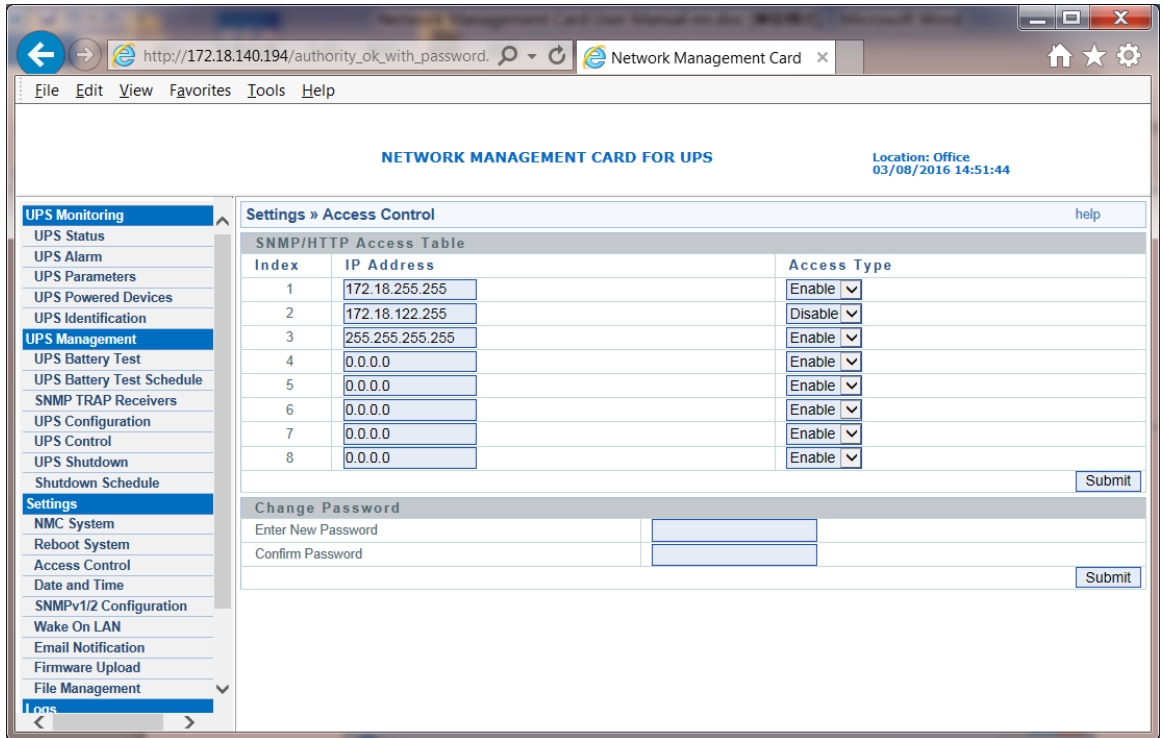

Diagram 3.1.12

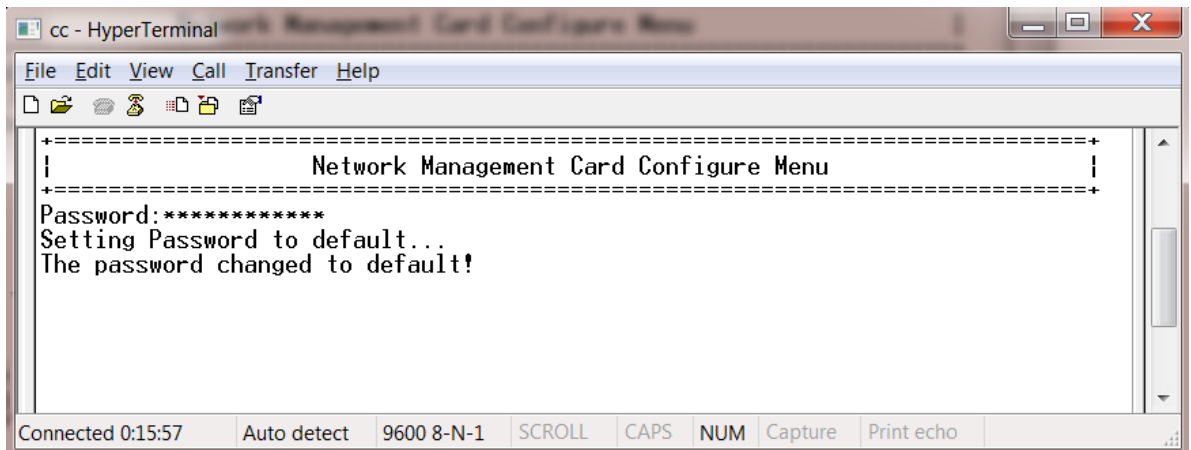

Diagram 3.1.13

3.2 UPS monitoring via web browser

3.2.1 UPS Status menu

UPS status menu can be accessed by **UPS Monitoring**→**UPS Status**. User can view real-time operating status of the UPS from the web page directly. Please refer to diagram 3.2.1.

Load Segment 1

This shows the current status of load segment 1.

Load Segment 2

This shows the current status of load segment 2

Network Management Card

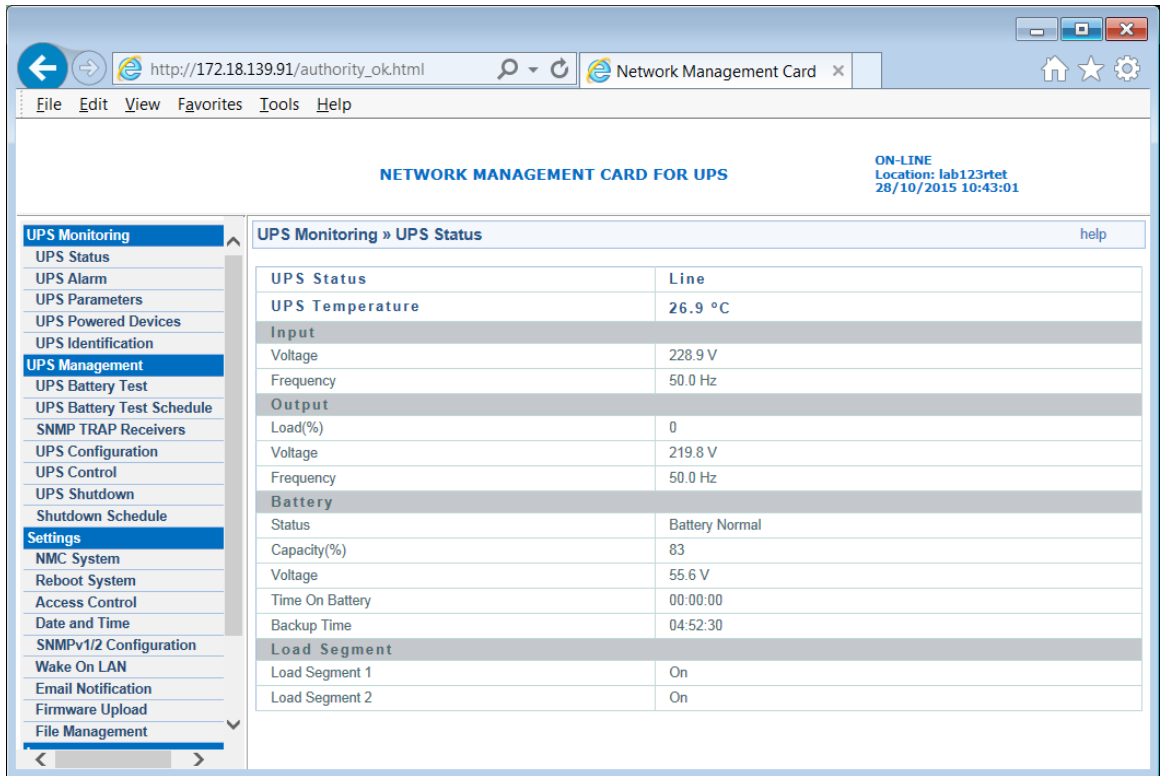
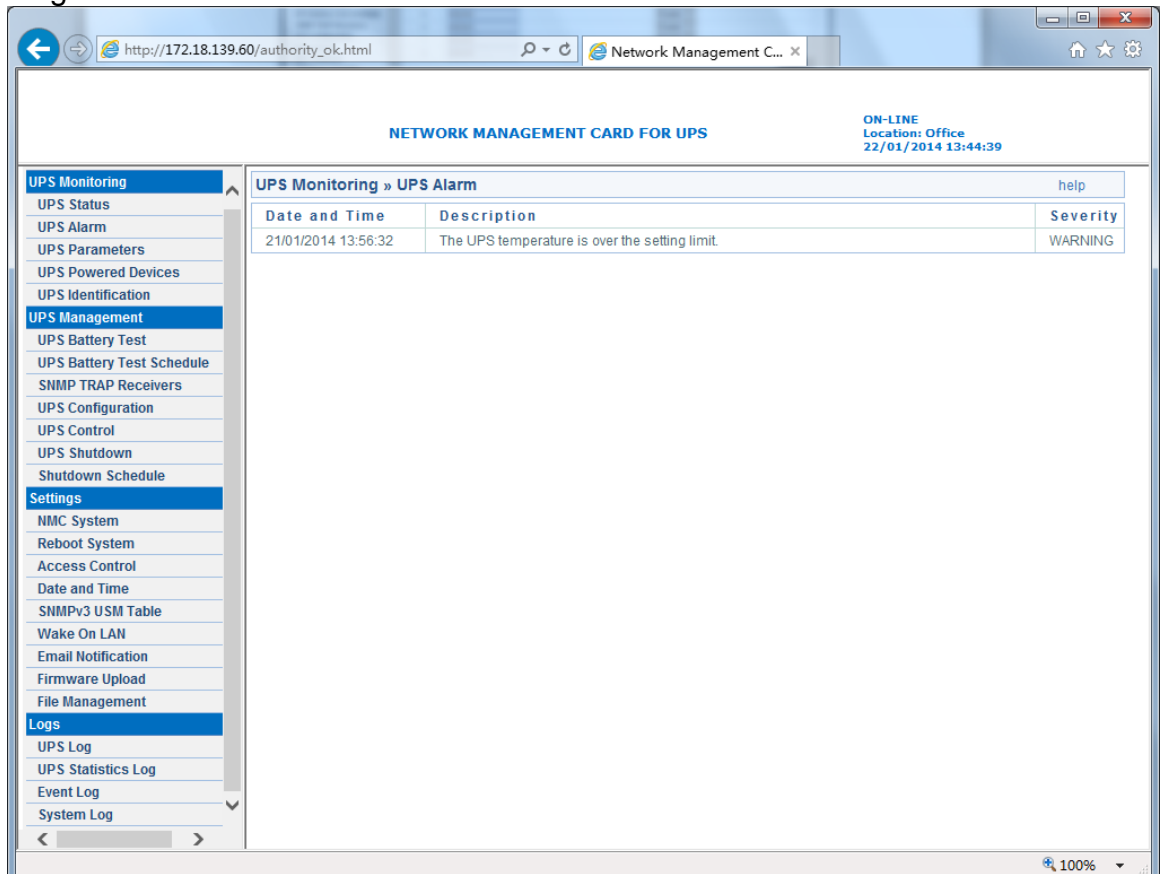

Diagram 3.2.1

3.2.2 UPS Alarm menu

UPS Alarm menu can be accessed by **UPS Monitoring**→**UPS Alarm**. User can view the current warning of UPS on the interface. Please refer to diagram 3.2.2.



Network Management Card

Diagram 3.2.2

3.2.3 UPS Parameters menu

UPS Parameters menu can be accessed by **UPS Monitoring**→**UPS Parameters**. User can view the rating parameters of UPS on the interface. Such as rating output voltage, rating output frequency, rating output power, different parameters shown on the interface is depended on different UPS type. Please refer to diagram 3.2.3.

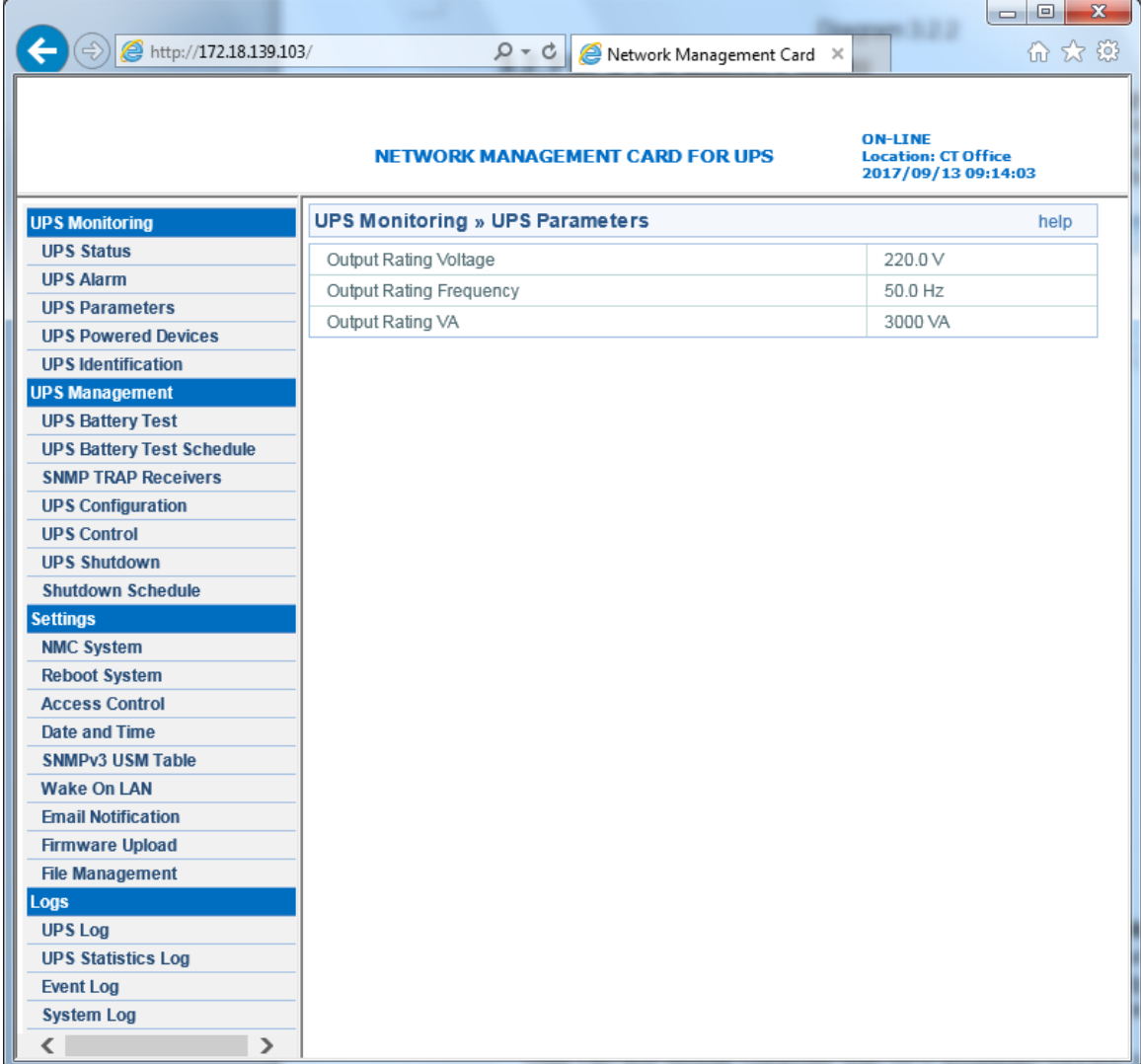

The screenshot shows a web browser window with the URL <http://172.18.139.103/>. The page title is "NETWORK MANAGEMENT CARD FOR UPS". The status is "ON-LINE" with "Location: CT Office" and "2017/09/13 09:14:03". The main content area is titled "UPS Monitoring » UPS Parameters" and includes a "help" link. A table displays the following parameters:

Output Rating Voltage	220.0 V
Output Rating Frequency	50.0 Hz
Output Rating VA	3000 VA

The left sidebar contains a navigation menu with the following items:

- UPS Monitoring
- UPS Status
- UPS Alarm
- UPS Parameters
- UPS Powered Devices
- UPS Identification
- UPS Management
- UPS Battery Test
- UPS Battery Test Schedule
- SNMP TRAP Receivers
- UPS Configuration
- UPS Control
- UPS Shutdown
- Shutdown Schedule
- Settings
- NMC System
- Reboot System
- Access Control
- Date and Time
- SNMPv3 USM Table
- Wake On LAN
- Email Notification
- Firmware Upload
- File Management
- Logs
- UPS Log
- UPS Statistics Log
- Event Log
- System Log

Diagram 3.2.3

3.2.4 UPS Powered Devices Menu

UPS Powered Devices menu can be accessed by **UPS Monitoring**→**UPS Powered Devices**. The table shows the amount of computers with SPS (System Protect Software) connected with NMC. Once UPS output is abnormal, NMC will send shutdown command to the computer with SPS, and computer will be shut down safely by SPS.

User can test remote computer with SPS shutdown function by configure test event.

Please refer to diagram 3.2.4.

Network Management Card

The screenshot displays a web browser window with the URL `http://172.18.139.60/authority_ok.html`. The page title is "NETWORK MANAGEMENT CARD FOR UPS" and it shows the system is "ON-LINE" at "Location: Office" on "22/01/2014 13:46:41". The left sidebar contains a navigation menu with categories: UPS Monitoring, UPS Management, Settings, and Logs. The "UPS Monitoring » UPS Powered Devices" menu item is selected. The main content area shows "The amount of connected devices is: 1" and a table with the following data:

Index	IP Address	Host Name	Date Time
1	172.18.139.21	BAOCNWHWP3004159.napa.ad.etn.com	22/01/2014 13:46:31

Below the table, there is a "Remote PC Shutdown Test" section with a dropdown menu set to "AC Failed" and a "Submit" button.

Diagram 3.2.4

3.2.5 UPS Identification menu

UPS Identification menu can be accessed by **UPS Monitoring**→**UPS Identification**. There will be UPS type, UPS description (refer to section 3.1.1), UPS firmware version, NMC firmware version and MAC address. Please refer to diagram 3.2.5.

Network Management Card

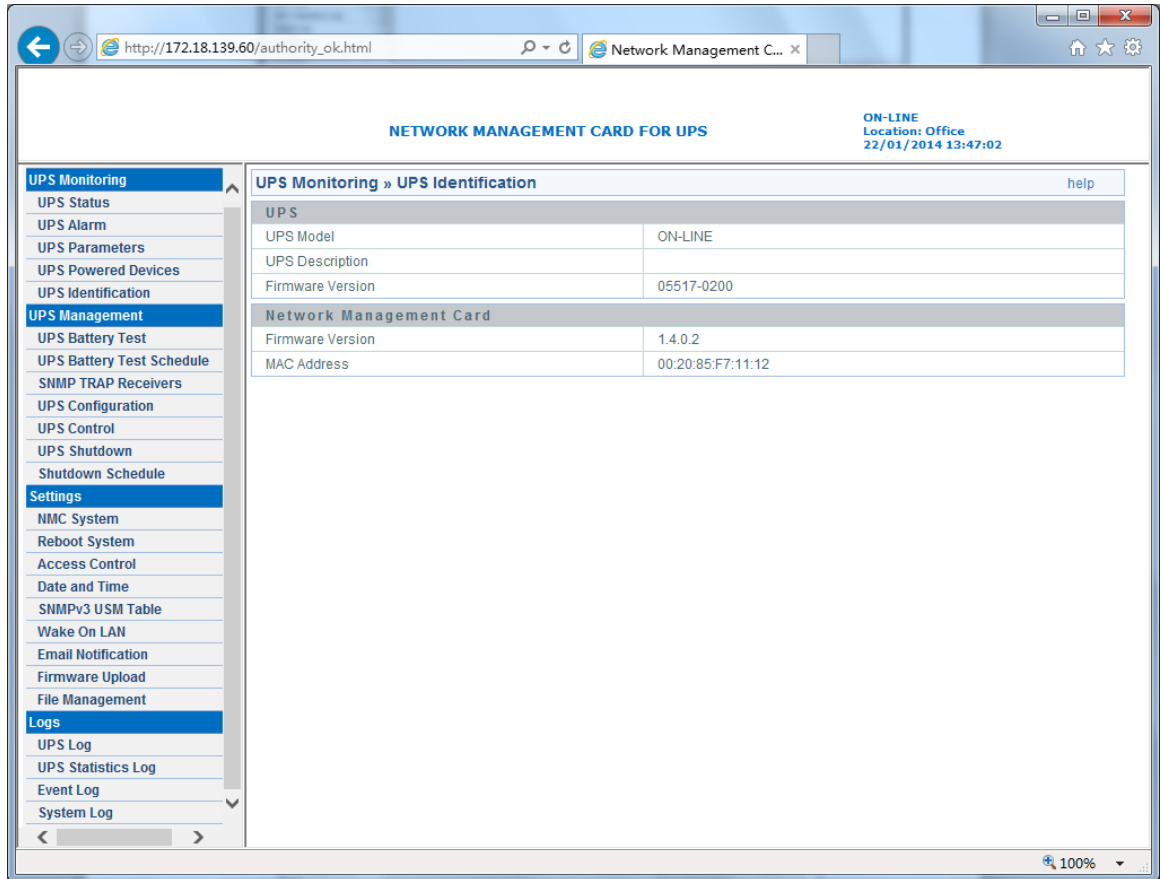

The screenshot shows a web browser window displaying the 'NETWORK MANAGEMENT CARD FOR UPS' interface. The browser address bar shows 'http://172.18.139.60/authority_ok.html'. The interface has a top navigation bar with the title 'NETWORK MANAGEMENT CARD FOR UPS' and status information: 'ON-LINE', 'Location: Office', and '22/01/2014 13:47:02'. A left sidebar contains a menu with categories: 'UPS Monitoring', 'UPS Management', 'Settings', and 'Logs'. The 'UPS Identification' menu item is selected. The main content area displays 'UPS Monitoring » UPS Identification' with a 'help' link. Below this, there are two tables. The first table, titled 'UPS', shows 'UPS Model' as 'ON-LINE', 'UPS Description' as empty, and 'Firmware Version' as '05517-0200'. The second table, titled 'Network Management Card', shows 'Firmware Version' as '1.4.0.2' and 'MAC Address' as '00:20:85:F7:11:12'. The browser window also shows a zoom level of 100% at the bottom right.

UPS	
UPS Model	ON-LINE
UPS Description	
Firmware Version	05517-0200

Network Management Card	
Firmware Version	1.4.0.2
MAC Address	00:20:85:F7:11:12

Diagram 3.2.5

3.2.6 UPS Log menu

UPS Log menu can be accessed by **Logs**→**UPS Log**. There are two hundred latest data logs shown on the interface at most. Please refer to diagram 3.2.6. User can export *upsdata.csv* file to view more data logs from file management interface, please refer to section 3.1.7.

Network Management Card

The screenshot shows a web browser window with the URL http://172.18.139.60/authority_ok.html. The page title is "NETWORK MANAGEMENT CARD FOR UPS". In the top right corner, it displays "ON-LINE", "Location: Office", and "22/01/2014 13:47:22".

The left sidebar contains a navigation menu with the following items:

- UPS Monitoring
 - UPS Status
 - UPS Alarm
 - UPS Parameters
 - UPS Powered Devices
 - UPS Identification
 - UPS Management
 - UPS Battery Test
 - UPS Battery Test Schedule
 - SNMP TRAP Receivers
 - UPS Configuration
 - UPS Control
 - UPS Shutdown
 - Shutdown Schedule
- Settings
 - NMC System
 - Reboot System
 - Access Control
 - Date and Time
 - SNMPv3 USM Table
 - Wake On LAN
 - Email Notification
 - Firmware Upload
 - File Management
- Logs
 - UPS Log
 - UPS Statistics Log
 - Event Log
 - System Log

The main content area is titled "Logs » UPS Log" and contains a table with the following columns: Date, Time, Input (Voltage, Frequency), Output (Voltage, Frequency), Load (%), Capacity(%), and Battery (Time On Battery (min)).

Date	Time	Input		Output		Load (%)	Capacity(%)	Battery Time On Battery (min)
		Voltage	Frequency	Voltage	Frequency			
22/01/2014	10:28:10	222.4	49.9	220.0	50.0	0	100	0.0
22/01/2014	10:29:10	222.0	50.0	220.0	49.9	0	100	0.0
22/01/2014	10:30:10	221.8	49.9	219.6	50.0	0	100	0.0
22/01/2014	10:31:10	221.6	49.9	220.3	50.0	0	100	0.0
22/01/2014	10:32:10	220.0	50.0	219.6	50.0	0	100	0.0
22/01/2014	10:33:10	220.3	50.0	220.0	50.1	0	100	0.0
22/01/2014	10:34:10	220.3	50.0	220.3	50.0	0	100	0.0
22/01/2014	10:35:10	220.0	50.0	220.0	50.0	0	100	0.0
22/01/2014	10:36:10	220.5	49.9	220.0	49.9	0	100	0.0
22/01/2014	10:37:10	220.7	50.0	220.0	50.0	0	100	0.0
22/01/2014	10:38:10	222.8	50.0	220.0	49.9	0	100	0.0
22/01/2014	10:39:10	222.8	50.0	219.8	50.0	0	100	0.0
22/01/2014	10:40:10	222.4	50.0	220.0	50.0	0	100	0.0
22/01/2014	10:41:10	223.1	49.9	219.6	49.9	0	100	0.0
22/01/2014	10:42:10	222.6	50.0	220.0	50.0	0	100	0.0
22/01/2014	10:43:10	222.0	49.9	220.0	49.9	0	100	0.0
22/01/2014	10:44:10	222.0	49.9	219.8	49.9	0	100	0.0
22/01/2014	10:45:10	222.0	50.0	220.3	49.9	0	100	0.0
22/01/2014	10:46:10	222.0	49.9	219.8	49.9	0	100	0.0
22/01/2014	10:47:10	221.6	49.9	220.5	50.0	0	100	0.0
22/01/2014	10:48:10	221.8	49.9	220.5	50.0	0	100	0.0
22/01/2014	10:49:10	220.7	50.0	220.3	50.0	0	100	0.0

Diagram 3.2.6

3.2.7 UPS Statistics Log menu

UPS Statistics Log menu can be accessed by **Logs**→**UPS Statistics Log**. This page shows a statistics log of the UPS parameters taken over a period of time. For each of the UPS parameters, minimum, maximum and the average values is shown in each of the records. Please refer to diagram 3.2.7. Statistics log interval can be changed by modifying the variable "Statistics Log Interval" in "NMC System" page.

Network Management Card

The screenshot shows a web browser window with the URL http://172.18.139.60/authority_ok.html. The page title is "NETWORK MANAGEMENT CARD FOR UPS" and it indicates the system is "ON-LINE" at "Location: Office" on "21/01/2014 13:35:47". A left-hand navigation menu includes categories like "UPS Parameters", "Settings", and "Logs". The "Logs » UPS Statistics Log" section is active, displaying a table of UPS statistics.

Start Date	Start Time	End Date	End Time	Input Voltage			Input Frequency			Output Voltage		
				Min	Avg	Max	Min	Avg	Max	Min	Avg	Max
06/01/2014	06:20:28	06/01/2014	07:20:28	218.2	221.3	223.7	49.9	49.9	50.0	221.0	221.0	222.4
06/01/2014	07:20:28	06/01/2014	08:20:28	218.2	221.6	225.1	49.9	50.0	50.0	221.0	221.0	222.4
06/01/2014	08:20:28	06/01/2014	09:20:28	214.0	218.7	221.0	49.9	50.0	50.0	221.0	221.0	222.4
06/01/2014	09:20:28	06/01/2014	10:20:28	212.6	217.6	219.6	49.9	49.9	50.0	221.0	221.0	222.4
06/01/2014	10:20:28	06/01/2014	11:20:28	211.2	219.5	223.7	49.9	50.0	50.0	219.6	221.0	221.0
06/01/2014	11:20:28	06/01/2014	12:20:28	215.4	222.3	223.7	49.9	49.9	50.0	219.6	221.0	221.0
06/01/2014	12:20:28	06/01/2014	13:20:28	215.4	220.7	223.7	49.9	49.9	50.0	219.6	220.9	221.0
06/01/2014	13:20:28	06/01/2014	14:20:28	215.4	220.2	222.4	49.9	50.0	50.0	219.6	220.9	222.4
06/01/2014	14:20:28	06/01/2014	15:20:28	216.8	220.3	222.4	49.9	49.9	50.0	219.6	221.1	222.4
06/01/2014	15:20:28	06/01/2014	16:20:28	214.0	219.5	222.4	49.9	49.9	50.0	219.6	221.0	221.0
06/01/2014	16:20:28	06/01/2014	17:20:28	215.4	221.0	222.4	49.9	49.9	50.0	221.0	221.0	221.0
06/01/2014	17:20:28	06/01/2014	18:20:28	215.4	219.7	222.4	49.9	50.0	50.0	221.0	221.0	221.0
06/01/2014	18:20:28	06/01/2014	19:20:28	215.4	220.8	223.7	49.9	50.0	50.0	221.0	221.0	221.0
06/01/2014	19:20:28	06/01/2014	20:20:28	216.8	222.0	223.7	49.9	49.9	50.0	221.0	221.0	221.0
06/01/2014	20:20:28	06/01/2014	21:20:28	216.8	222.3	225.1	49.9	50.0	50.0	221.0	221.0	221.0

Diagram 3.2.7

3.2.8 Event Log menu

Event Log menu can be accessed by **Logs**→**Event Log**. There are two hundred latest event logs shown on the interface at most. Please refer to diagram 3.2.8. User can export *upsevent.csv* file to view more event logs from file management interface, please refer to section 3.1.7.

Network Management Card

The screenshot displays a web browser window with the URL http://172.18.139.60/authority_ok.html. The page title is "NETWORK MANAGEMENT CARD FOR UPS". In the top right corner, it shows "ON-LINE", "Location: Office", and "22/01/2014 13:48:08". A left-hand navigation menu includes categories like "UPS Monitoring", "Settings", and "Logs". The "Logs" section is expanded to show "Event Log". The main content area is a table with columns for "Date", "Time", and "Description".

Date	Time	Description
25/12/2013	08:45:39	WARNING: Utility power not available.
25/12/2013	08:47:39	INFORMATION: Utility power has restored.
25/12/2013	08:48:25	WARNING: Utility power not available.
25/12/2013	08:51:29	INFORMATION: Utility power has restored.
25/12/2013	08:52:08	WARNING: Utility power not available.
25/12/2013	08:53:09	INFORMATION: Utility power has restored.
25/12/2013	08:53:41	WARNING: Utility power not available.
25/12/2013	08:55:45	INFORMATION: Utility power has restored.
31/12/2013	13:12:51	WARNING: UPS Output Off.
31/12/2013	13:22:26	INFORMATION: UPS Output On.
31/12/2013	13:22:26	INFORMATION: The UPS has enabled bypass.
31/12/2013	13:22:30	INFORMATION: The UPS is not on Bypass and return to normal status.
02/01/2014	20:30:57	WARNING: Utility power not available.
02/01/2014	20:37:09	SEVERE: The UPS batteries are low and will soon be exhausted.
02/01/2014	20:43:35	WARNING: The UPS batteries capacity is lower than setting limit.[29% < 30%]
02/01/2014	20:46:30	WARNING: UPS Output Off.
05/01/2014	19:52:53	WARNING: Utility power not available.
05/01/2014	20:02:16	SEVERE: The UPS batteries are low and will soon be exhausted.
05/01/2014	20:04:38	WARNING: The UPS batteries capacity is lower than setting limit.[29% < 30%]
05/01/2014	20:07:32	WARNING: UPS Output Off.
08/01/2014	17:22:02	WARNING: Utility power not available.
08/01/2014	17:22:04	INFORMATION: Utility power has restored.
09/01/2014	16:57:56	WARNING: Utility power not available.
09/01/2014	17:07:27	SEVERE: The UPS batteries are low and will soon be exhausted.
09/01/2014	17:09:59	WARNING: The UPS batteries capacity is lower than setting limit.[29% < 30%]

Diagram 3.2.8

3.3 UPS control via web browser

Please Note: Before implementing the NMC setting for all configuring parameters, user has to become NMC administrator first. While configure parameters for NMC via web browser, there will be a pop-up dialog to ask the name and password of NMC administrator. Only NMC password can be changed, regarding to change password by serial COM port, please refer to the item 15 of the section 2.1.

3.3.1 UPS Battery Test menu

UPS Battery Test menu can be accessed by **UPS Management**→**UPS Battery Test**. UPS battery latest test result and test time is shown on the interface. User can configure “Quick Battery Test”, “Test Until Battery Low”, “Timed Test”, “Cancel Test” and “Clear Test Information”. For some offline UPS, UPS can’t support “Test Until Battery Low” and “Timed Test” function, the function is depended on UPS firmware. Please refer to diagram 3.3.1.

Network Management Card

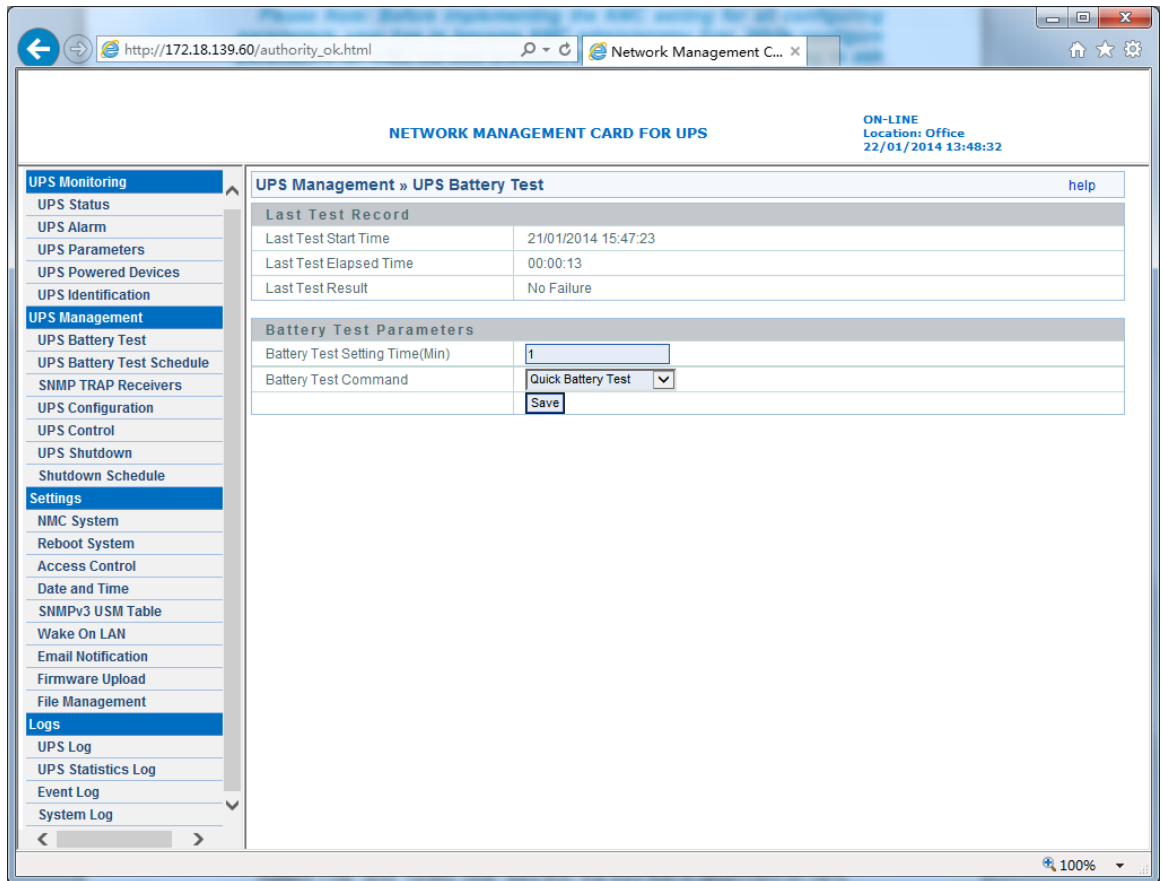

Diagram 3.3.1

3.3.2 UPS Battery Test Schedule menu

UPS Battery Test Schedule menu can be accessed by **UPS Management**→**UPS Battery Test Schedule**. User can configure schedule test on specific day or weekly day. User can configure “Quick Battery Test”, “Test Until Battery Low” and “Timed Test”. “Battery Test setting Time” is for “Timed Test” function. For some offline UPS, UPS can’t support “Test Until Battery Low” and “Timed Test” function, the function is depended on UPS firmware. Please refer to diagram 3.3.2.

Network Management Card

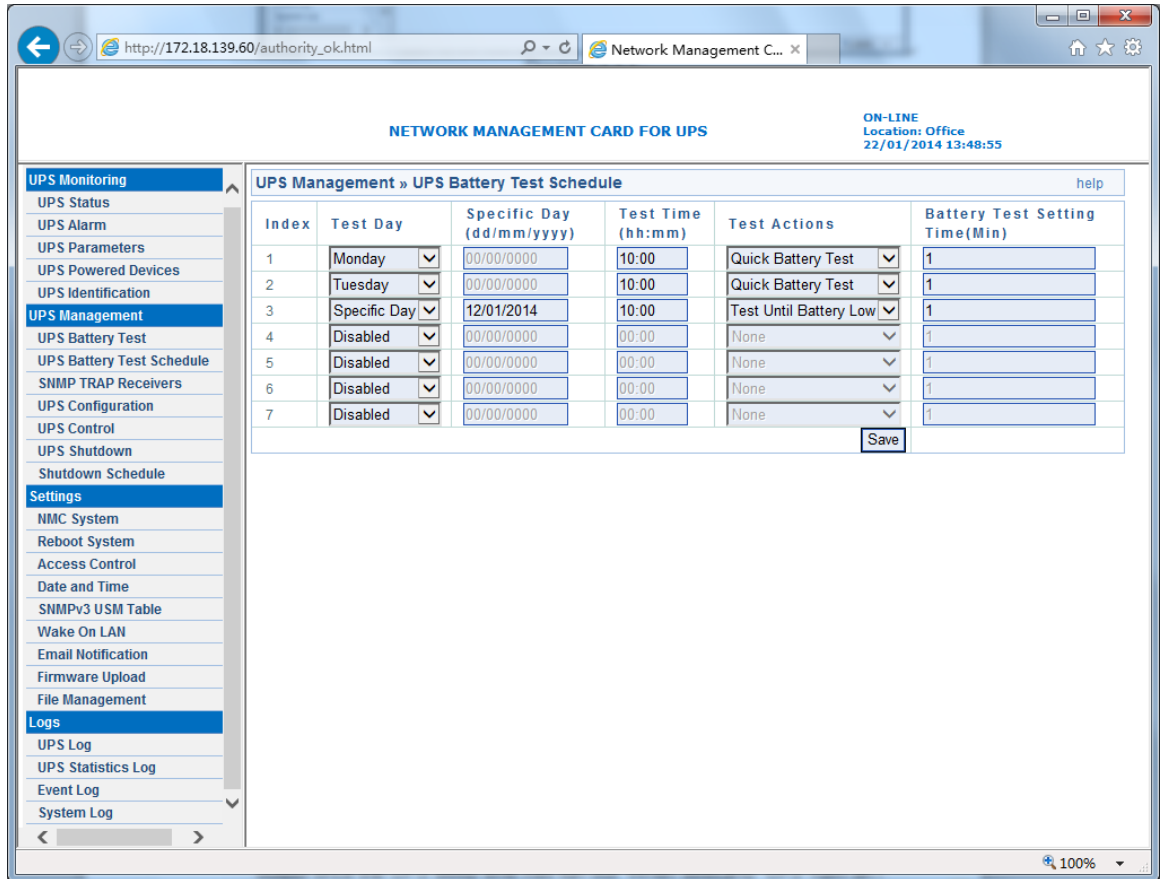

Diagram 3.3.2

3.3.3 UPS Control menu

UPS Control menu can be accessed by **UPS Management**→**UPS Control**. User can control UPS output on or off on the interface, please refer to diagram 3.3.3.

When selecting "UPS turn off" item, NMC will send shutdown command to UPS, UPS will shut down output once the delay time has run out. When selecting "UPS Sleep" item, NMC will send shutdown command to UPS, UPS will shut down output once the delay time has run out, and UPS will turn on output once the UPS sleep time has run out. When selecting "UPS Turn on / Cancel shutdown" item, NMC will send cancel shutdown command to UPS, and UPS will turn on output. Users can manual Turn On or Turn off UPS Load Segment in this page.

Network Management Card

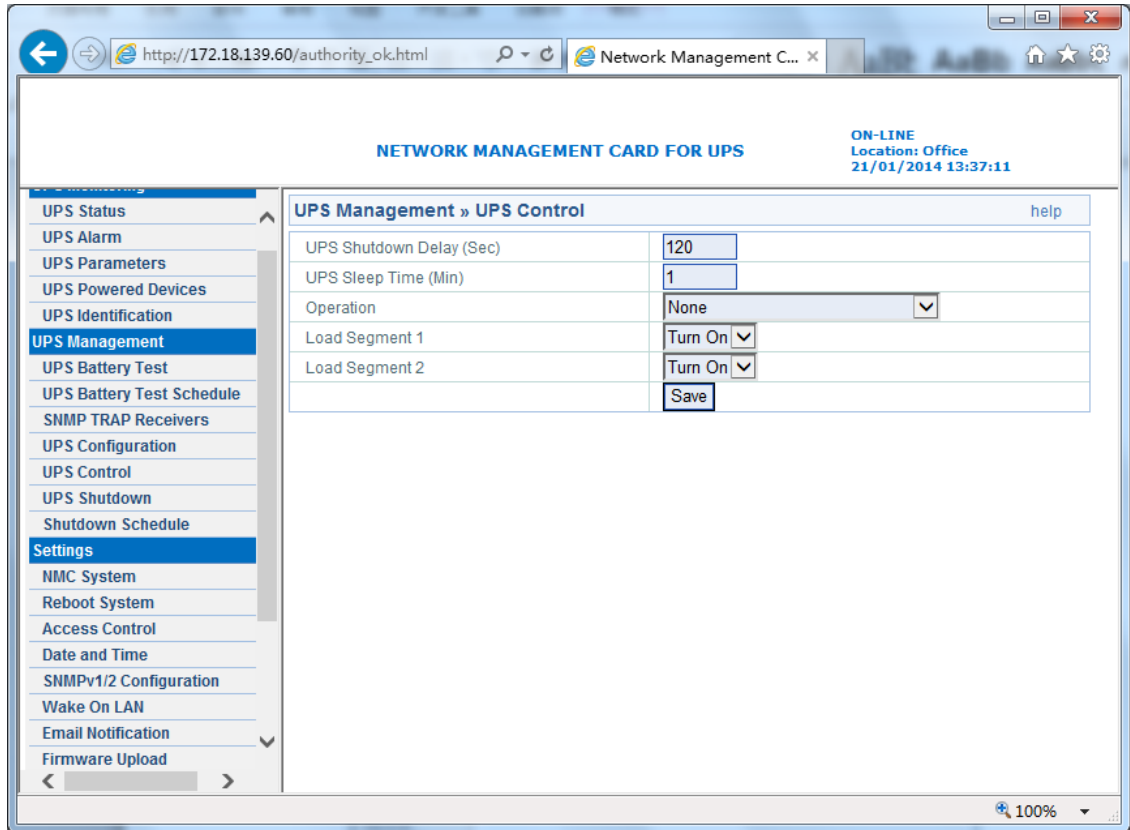

Diagram 3.3.3

3.3.4 UPS Shutdown Schedule menu

UPS Shutdown Schedule menu can be accessed by **UPS Management**→**UPS Shutdown Schedule**. User can control UPS output on or off on specific day or on weekly day, please refer to diagram 3.3.4.

Network Management Card

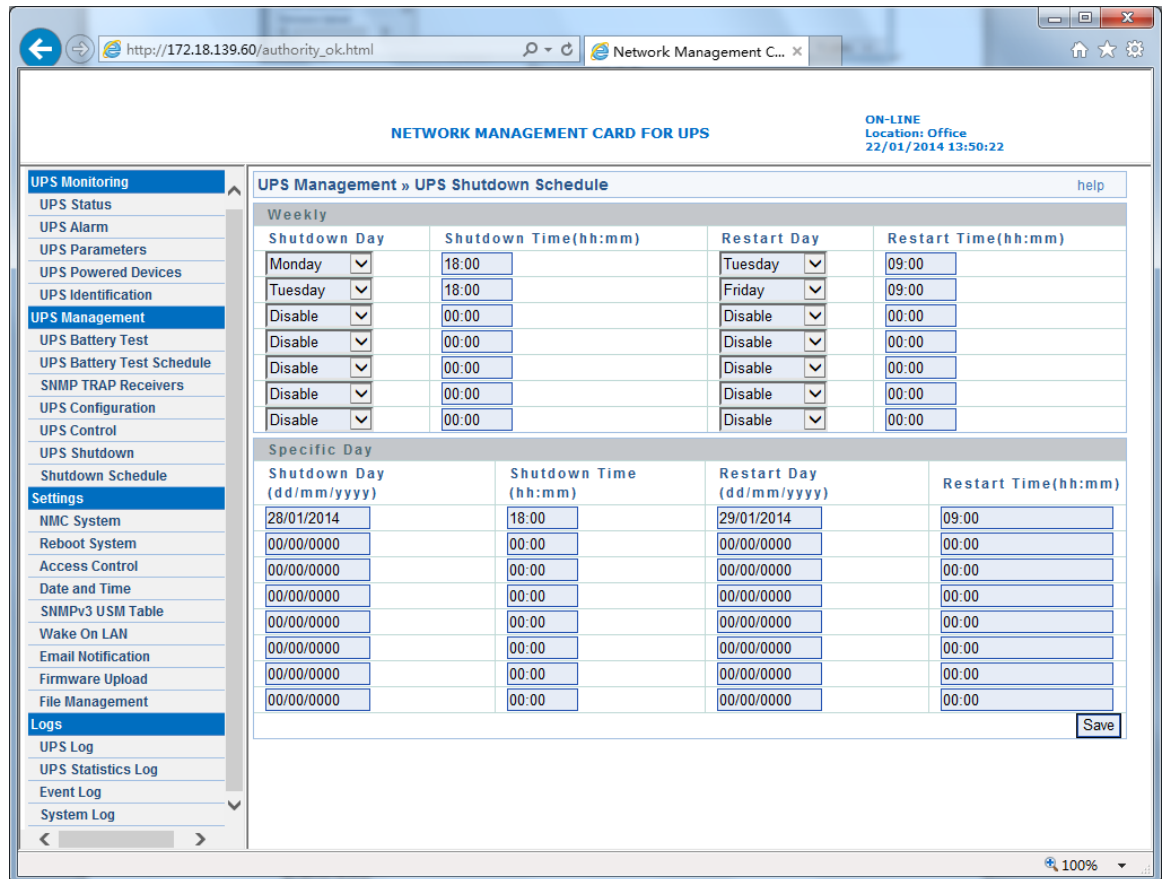

Diagram 3.3.4

3.3.5 UPS Shutdown menu

UPS Shutdown menu can be accessed by **UPS Management**→**UPS Shutdown**. Please refer to diagram 3.3.5. When the selected event happens, NMC will inform the computer installed with SPS (System Protect System) of the event and send the shutdown command to the computer. Here, the computer installed with SPS is the computer shown on UPS powered devices interface (refer to section 3.2.4).

Action type:

- Disable: It means that NMC will do nothing even the event happens on UPS.
- Warning: It means that NMC will inform the computer installed with SPS of the event once the shutdown condition happens.
- Client Shutdown: It means that NMC will inform the computer installed with SPS of the event and send shutdown command to the computer once the shutdown condition happens.
- “UPS Turn Off” means that NMC will inform the computer installed with SPS of the event, send shutdown command to the computer, and also send shutdown command to UPS once the shutdown condition happens, when the delay time has run out, UPS will shut down output. The default value of delay time is 120 seconds.

Warning period means the overall time the warning will be repeatedly once event happens. Warning interval means that NMC will inform the event to the computer installed with SPS every short period once event happens. **N = (Warning period / Warning interval) + 1**, N means the warning times.

Please Note: for client shutdown setting information, please refer to [System Protect Software User Manual.pdf](#)

Network Management Card

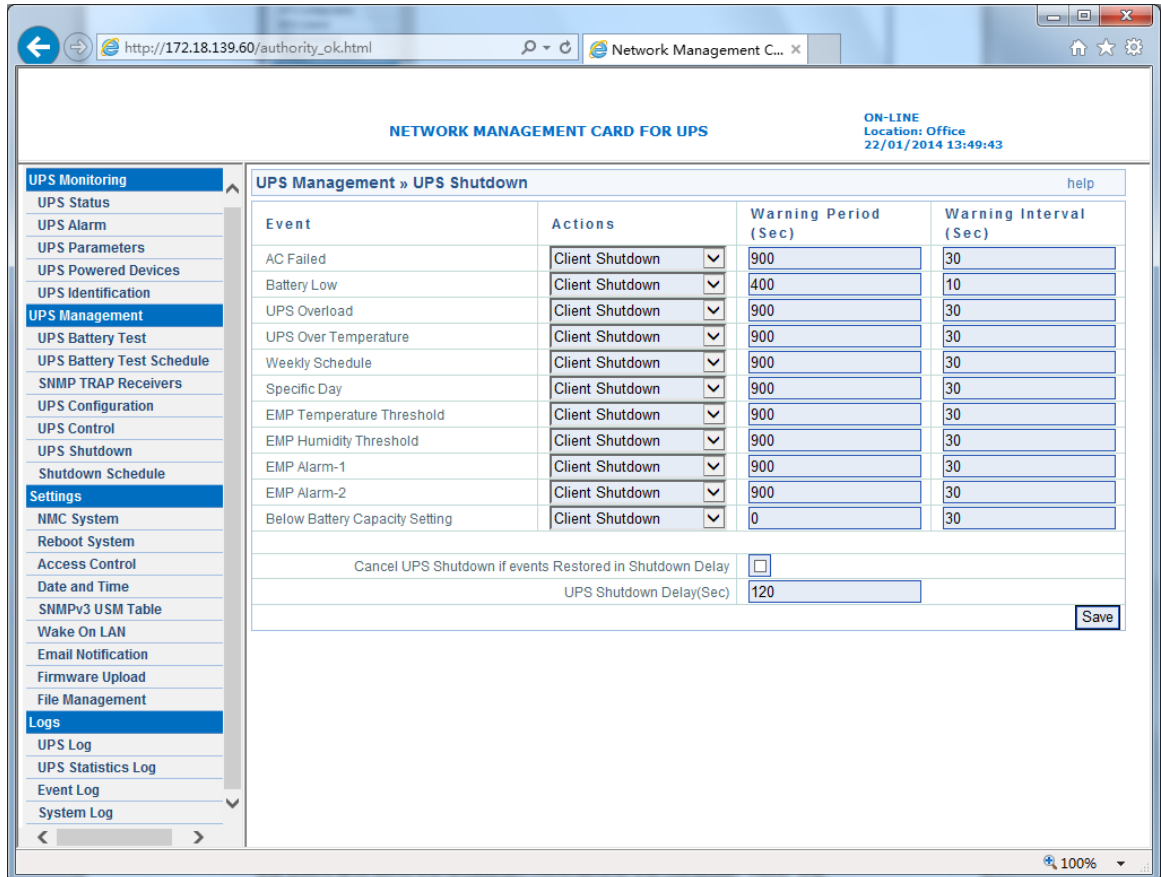

Diagram 3.3.5

3.3.6 UPS Configuration menu

UPS Configuration menu can be accessed by **UPS Management**→**UPS Configuration**. User can configure the limited point of UPS overload and over-temperature. For Innova UPS, User can configure UPS buzzer bee. User can configure the limited point of EMP temperature value and humidity value. User can configure the warning setting of EMP: “Normally open”, “Normally closed” or “Not used”. User also can configure UPS last replaced date. User can set the lower limit of battery capacity. When the battery capacity is below the set point, NMC will take action that is specified in the UPS Shutdown menu. The default value is 30%. User can set the lower limit of battery backup time. When the battery backup time is below the set point, NMC will take action that is specified in the UPS Shutdown menu.

Load Segment

The Load Segment Control feature contains parameters to control each UPS load segment.

Shutdown Timer

Shut down the appointed load segment when the utility power fails for the amount of time equal to the setting time. The value range is -1 to 32,767 seconds.

Startup Timer

Start up the appointed load segment when the set timer expires after utility power is restored. The value range is -1 to 32,767 seconds.

Refer to the following diagram 3.3.6.

Network Management Card

The screenshot shows a web browser window with the URL `http://172.18.139.91/authority_ok.html`. The page title is "NETWORK MANAGEMENT CARD FOR UPS". The status is "ON-LINE" with location "lab123rtet" and time "28/10/2015 10:46:30".

The left sidebar contains a navigation menu with categories: UPS Monitoring, UPS Management, Settings, and Logs. The "UPS Management » UPS Configuration" page is active.

The main content area is divided into several sections:

- UPS Configuration:**
 - Over Load Set Point(%): 21
 - Over Temperature Set Point(°C): 50
 - Buzzer: Off
 - Save button
- EMP:**
 - Mode: Auto
 - Sensor table:

Sensor	Description	Low Point	High Point
Temperature(°C)	uu	<input checked="" type="checkbox"/> 10	<input type="checkbox"/> 44
Humidity(%)	rwr	<input type="checkbox"/> 46	<input type="checkbox"/> 99
Alarm-1	hty	Normally Open	
Alarm-2	asewe	Normally Open	

 - Save button
- UPS Battery:**
 - Last Replace Date(dd/mm/yyyy): 03/07/2015
 - Shutdown when battery capacity is below(%): 30
 - Shutdown when battery backup time is below(Min): 0
 - Save button
- Load Segment:**

	Shutdown timer	Startup timer
Load Segment 1(Sec)	130	0
Load Segment 2(Sec)	130	0

- Save button

Diagram 3.3.6

Chapter 4 NMC & UPS management via SNMP

Please note: if user wants to use NMC via SNMP protocol, please make sure IP address and Gateway of NMC correct. Please refer to section 2.1 or section 3.1.1 for IP address and Gateway settings.

NMC support SNMP protocol, user can manage NMC and UPS via SNMP NMS (Network Management Station). Load the NMC MIB to the database of SNMP NMS, and user can read or configure the parameters of NMC and UPS. The read community strings is "**public**", and the write community strings is "**private**." NMC support two type MIB: one is **RFC1628.mib**, the other is **EPPC.mib**. MIB files can be found in NMC CD-ROM packaged with NMC.

Furthermore, NMC can be monitored by Winpower software via SNMP protocol. For more detail information, please refer to the user manual of Winpower.

Chapter 5 NMC Upgrade Tool - Find NMC in the LAN

Via NMC Upgrade Tool, user can find NMC automatically and quickly in the LAN. Please refer to the following diagram.

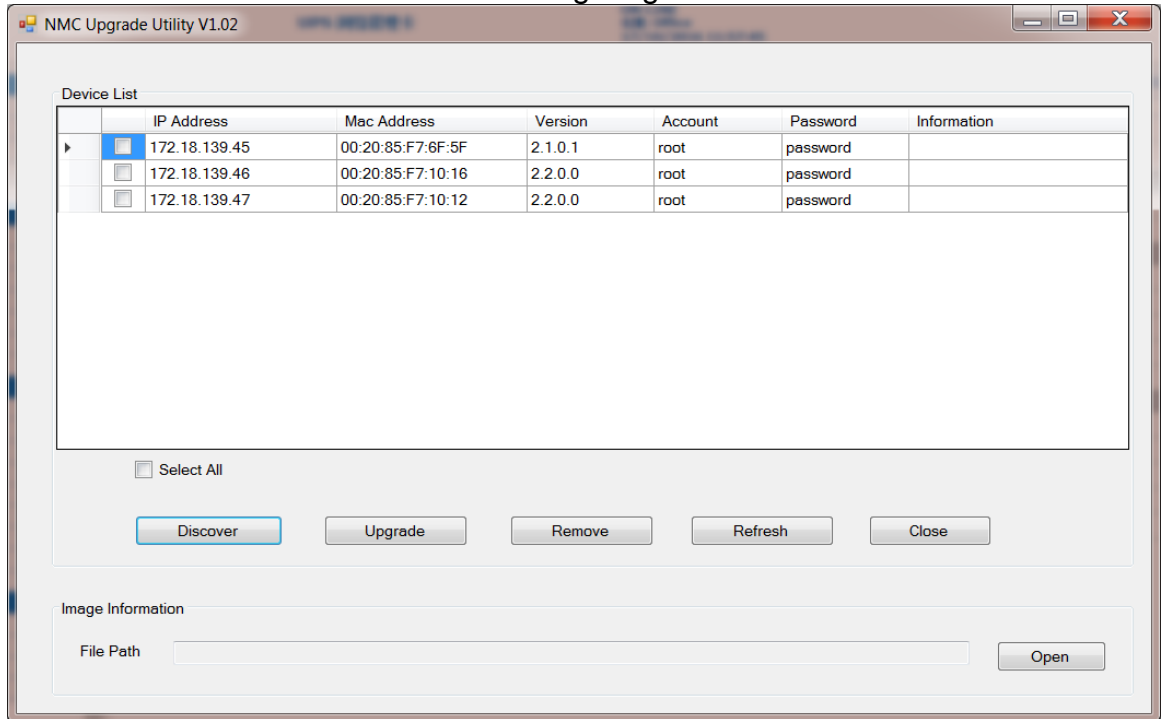

NMC Upgrade Tool can be found in NMC CD-ROM packaged with NMC, NMC Upgrade Tool supports Windows XP / Windows 7.